

Model: CPC2-28

Technical features

Reference	Dimensions (mm)	Columns	Dish diameter (mm)	Dish capacity	Power (W)	Description
19005889	920 x 495 x 895	2	180-280	90	960	-

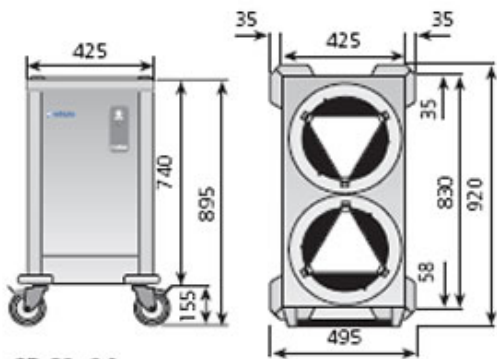

CPC2-28

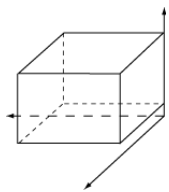

Packaging dimensions:

Depth: 550,000 MM

Width: 970,000 MM

Height: 950,000 MM







Gross weight: 70,000 KG

General features

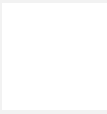
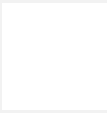
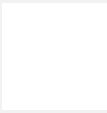







- Especially designed for heating, maintaining and distributing warm plates.
- Doubled wall with internal isolation. With its highly-insulated walls, heat losses are reduced thus obtaining energy savings.
- Adjustable plate size system, with 3 flexible rods that work as a plate stacking guides.
- Special system with steel springs that resist high temperatures, keeping the plates at a constant level for easy service.
- Elasticity can be adjusted according to the weight of the plates, turning on/off the springs.
- 2 or 4 column trolleys available. For 4 columns models, there are two types of columns: for plates from 180 to 280 mm diameter and for plates from 240 to 340 mm diameter.
- Thermostat to monitor, control and regulate the hot table temperature at desired setpoint.
- Four (4) sound-proof castors of 125 mm diameter, two of them with brakes for an easy handling and safer use. Non-marking, special rubber bumpers to protect against direct impacts in all four (4) corners
- Made of stainless steel.
- Lids to keep the right plate temperature, as an optional accessory.
- Estimate xapacity of 40/45 plates per column.

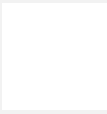

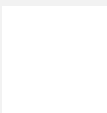
Spare parts

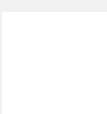
Reference	SAP reference	Description	Recommended	Replaced	Price
6025210036	12050277	SS M4 GROWER WASHER DIN127			0.00 EUR
	D109010005	12032431	ARO SUP. DPN-28 391MM CAST		0.00 EUR
	D109010048	12050432	BASE PLATE DPC-DPN-28		0.00 EUR
	6005010001	12037077	CORNER OF 3120X150X15 MM.		0.00 EUR
	D109010029	12050426	DPN BEARING STANCHION		0.00 EUR
	6033090014	12037338	BRONZE THREADED SHAFT INSIDE		0.00 EUR
	6025090038	12037654	THREADED BEARING (NO CHROMIUM)		0.00 EUR
	6021130001	12037293	SWITCH BIPOLAR AMB. ON/OFF	✓	0.00 EUR
	6021390008	12033892	HOSE.CURL 3X1,5mm1m		0.00 EUR
	6033090015	12037032	SPRING TRACTION L-120 N ° 3	✓	0.00 EUR
	6003010002	12044928	BUMPER 90° GREY		0.00 EUR
	6021130003	12037853	PILOT AMB.FUNCION	✓	0.00 EUR

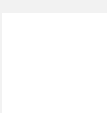
Spare parts

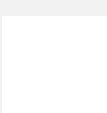
Reference	SAP reference	Description	Recommended	Replaced	Price
6013110001	12050222	GLASCOAIR 3000X1200X25 PLATE			0.00 EUR
	D109010035	12050429	LOWER PLATE TRIANGLE DISPENSER 2		0.00 EUR
	D109010036	12050430	UPPER PLATE TRIANGLE DISPENSER 2		0.00 EUR
	6021210004	12036956	PLUG IN TERMINAL 4 POLES FV-173		0.00 EUR
	6021250084	12044926	ELEMENT 220 V, 480 W EN "M" CPC	✓	0.00 EUR
	6003010123	12037097	DPN BEARINGS SHAFTLESS		0.00 EUR
	6033130009	12033956	WHEEL WITH BRAKE D125 (77X67)		0.00 EUR
	6033130013	12034570	WHEEL WITHOUT BRAKE D125-PLAT.77X67	✓	0.00 EUR
	6003010094	12037118	HOT VEHICLES HANDLE SUPPORT (BLUE)	✓	0.00 EUR
	D109170004	12050434	TAPA PLATAFORMA CPC-2-4-28		0.00 EUR
	6021350004	12034534	THERMOSTAT.0-90 ° C NT127A0	✓	0.00 EUR
	6025090022	12037874	TOR INOX M6X10 DIN TRL EXTRA		0.00 EUR

Spare parts

Reference	SAP reference	Description	Recommended	Replaced	Price
6025090024	12037871	TOR M6X35 AVELL ALLEN NEGRO			0.00 EUR
	D107050005	12044413	HANDLE TUBE CPC2-28		0.00 EUR
6027170007	12035819	DPN REGULATING BEARING			0.00 EUR