

Model: CNB-C

Technical features

Reference	Utility	Total dimensions (mm)	Objects dimensions (mm)
19005230	Trays and cutlery	560 x 640 x 1335	530 x 370 (maximum)

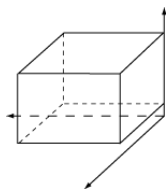
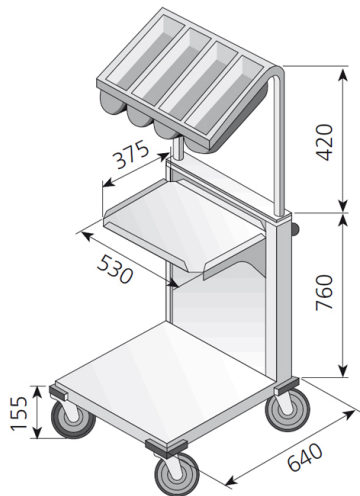

Packaging dimensions:

Depth: 640,000 MM

Width: 665,000 MM

Height: 1.385,000 MM

Gross weight: 36,000 KG

General features

Especially designed for storing and transporting of trays and dishwashing baskets.

Made of stainless steel.

Construction allows for holding trays or baskets at an appropriate level.

Equipped with 4 castors dia. 125 mm, including 2 with brakes.

APPROXIMATE CAPACITY AND DIMENSIONS:

Trays: CNB, CNB-C

Up to 120 trays, standard sizes 530 x 370, 480 x 370, 450 x 370 mm.

Up to 120 trays with dimensions equal to those of the GN 1/1 container 325 x 530 mm.





Up to 200 fast food type trays 350 x 270 mm.

Baskets: CNC

Up to 6 baskets 500 x 500 mm, 110 mm high.

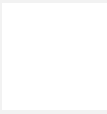
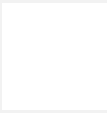

Spare parts

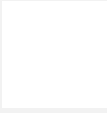
Reference	SAP reference	Description	Recommended	Replaced	Price
C109010007	12033369	CNB-C TRAY			0.00 EUR
	6005010001	12037077	CORNER OF 3120X150X15 MM.		0.00 EUR
	6033130037	12036894	CAP DIAM: 25		0.00 EUR
	6033090016	12036360	SPRING.TRACTION.L-150X25EXT.2H INOX N1	✓	0.00 EUR
	6003010002	12044928	BUMPER 90° GREY		0.00 EUR
	6033130009	12033956	WHEEL WITH BRAKE D125 (77X67)		0.00 EUR
	6033130013	12034570	WHEEL WITHOUT BRAKE D125-PLAT.77X67	✓	0.00 EUR
	6003010094	12037118	HOT VEHICLES HANDLE SUPPORT (BLUE)	✓	0.00 EUR
	6025050034	12050254	SCREW M10X40 ALLEN DIN 912		0.00 EUR
	6025130002	12037889	TUERCA ZIN M10		0.00 EUR